

# INSTRUCTION MANUAL

# DEWALT®

**31° CLIPPED HEAD FRAMING NAILER  
MODEL: D51822-XE**

**20° FULL ROUND HEAD FRAMING NAILER  
MODEL: D51844-XE**





DeWALT Industrial Tool Co.,  
701 East Joppa Road, Baltimore, MD 21286 • 20 Fletcher Road, Mooroolbark, VIC 3138 Australia  
(APR04) Form No. 623992-00 D51822-XE, D51744-XE Copyright © 2004

The following are trademarks for one or more DeWALT power tools: the yellow and black color scheme; the "D" shaped air intake grill; the array of pyramids on the handgrip; the kit box configuration; and the array of lozenge-shaped humps on the surface of the tool.

## SAVE THESE INSTRUCTIONS

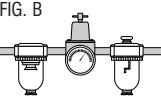
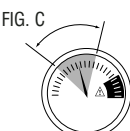
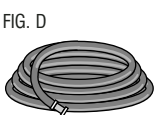
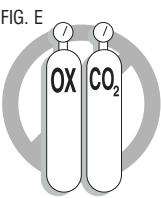
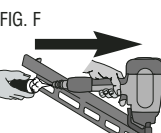
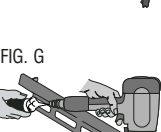
### Important Safety Instructions for Pneumatic Tools

**WARNING:** When using any pneumatic tool, all safety precautions, as outlined below, should be followed to avoid the risk of death or serious injury. Read and understand all instructions before operating the tool.

- FIG. A  **Actuating tool may result in flying debris, collation material, or dust which could harm operator's eyes.** The operator and all those persons in the general area should wear safety glasses with permanently attached side shields. Approved safety glasses are imprinted with the characters "Z87.1". It is the employer's responsibility to enforce the use of eye protection equipment by the tool operator and other people in the work area. (Fig. A)
- FIG. B  **Always wear appropriate personal hearing and other protection during use.** Under some conditions and duration of use, noise from this product may contribute to hearing loss. (Fig. A)
- FIG. C  **Use only clean, dry, regulated air.** Condensation from an air compressor can rust and damage the internal workings of the tool. (Fig. B)
- FIG. D  **Regulate air pressure. Use air pressure compatible with ratings on the nameplate of the tool.** (Not to exceed 120 psi, 8.3 bar) Do not connect the tool to a compressor rated at over 175 psi. The tool operating pressure must never exceed 175 PSI even in the event of regulator failure. (Fig. C)
- FIG. E  **Use air hoses rated for safe operation of the tool.** Hoses rated for a maximum operating pressure of 150 PSI or 150% of the maximum system pressure, whichever is greater, must be utilized. (Fig. D)
- FIG. F  **Do not use bottled gases to power this tool.** Bottled compressed gases such as oxygen, carbon dioxide, nitrogen, hydrogen, propane, acetylene or air are not for use with pneumatic tools. Danger of explosion and/or serious personal injury may result. (Fig. E)
- FIG. G  **Use couplings that relieve all pressure from the tool when it is disconnected from the power supply.** Use hose connectors that shut off air supply from compressor when the tool is disconnected. (Fig. F)
- FIG. H  **Disconnect tool from air supply when not in use. Always disconnect tool from air supply and remove fasteners from magazine before leaving the area or passing the tool to another operator. Do not carry tool to another work area with air supply connected. Do not make adjustments, remove magazine, perform maintenance or clear jammed fasteners while connected to the air supply.** If the contact trip is adjusted when the tool is connected to the air supply and nails are loaded, accidental discharge may occur. (Fig. G)
- FIG. I  **Do not remove, tamper with, or otherwise cause the tool, trigger, or contact trip to become inoperable.** Do not tape or tie trigger or contact trip in the ON position. Do not remove spring from contact trip. Uncontrolled discharge could result. (Fig. H)
- FIG. J  **Do not operate a tool if any portion of the tool, trigger, or contact trip is inoperable, disconnected, altered, or not working properly.** Leaking air, damaged parts or missing parts should be repaired or replaced before use. (Fig. I)
- FIG. K  **Do not alter or modify the tool in any way.** (Fig. J)
- FIG. L  **Always assume that the tool contains fasteners.**
- FIG. M  **Do not point the tool at co-workers or yourself at any time.** No horseplay! Work safe! Respect the tool as a working implement. (Fig. K)
- FIG. N  **Keep bystanders, children, and visitors away while operating a power tool.** Distractions can cause you to lose control.
- FIG. O  **Do not carry the tool from place to place holding the trigger.** Accidental discharge could result.
- FIG. P  **Always use trigger lock-off when tool is not in immediate use.** Using the trigger lock-off will prevent accidental discharge.
- FIG. Q  **Do not overreach.** Maintain proper footing and balance at all times. (Fig. L)
- FIG. R  **Make sure hose is free of obstructions or snags.** Entangled or snarled hoses can cause loss of balance or footing.

## EXTERNAL TOOL PARTS

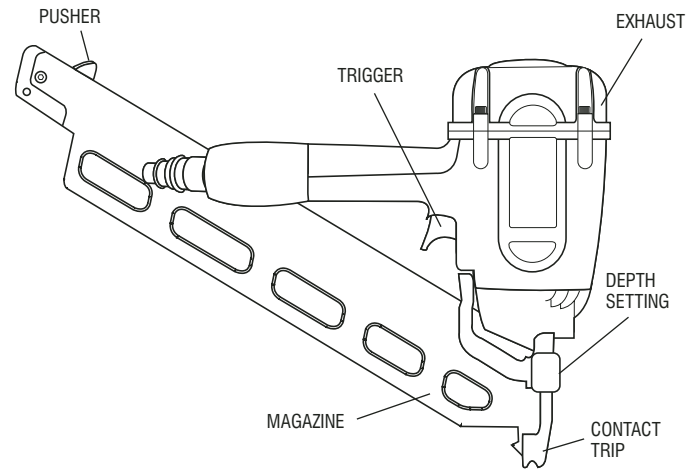

## TOOL SPECIFICATIONS

	D51822 Clipped Head	D51844 Full Round Head
Height	12-3/4" (32.4 cm)	12-3/4" (32.4 cm)
Width	5" (12.7 cm)	5" (12.7 cm)
Length	18 5/8" (47.3 cm)	20 3/4" (52.7 cm)
Weight	7.3 lb (3.40 kg)	7.4 lb (3.44 kg)
Magazine Angle	31°	20°
Recommended Operating Pressure	70 - 120 psig (4.9 to 8.3 bar, 5 to 8.5 kg/cm <sup>2</sup> )	70 - 120 psig (4.9 to 8.3 bar, 5 to 8.5 kg/cm <sup>2</sup> )
Air consumption per 100 cycles	7.2 cfm @ 100 psi 203.9 l/m @ 6.9 bar	7.2 cfm @ 100 psi 203.9 l/m @ 6.9 bar
Air consumption per single shoot	.072 cfm @ 100 psi 2.039 l/m @ 6.9 bar	.072 cfm @ 100 psi 2.039 l/m @ 6.9 bar
Loading capacity	Up to 80 Nails	Up to 65 Nails

## NAIL SPECIFICATIONS

	D51822 Clipped Head	D51844 Full Round Head
Nail Lengths	2" - 3-1/2" (50 mm - 90 mm)	2" - 3-1/2" (50 mm - 90 mm)
Shank Diameters	.113" - .131" (2.9 mm - 3.3 mm)	.113" - .148" (2.9 mm - 3.8 mm)
Nail Stick Angles	31° - 34°	20° - 22°
Shank Types	Smooth, Ring, Screw	Smooth, Ring, Screw

FIG. J



FIG. K



FIG. L

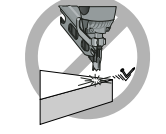

FIG. M



FIG. N

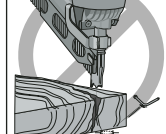

FIG. O

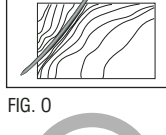

FIG. P

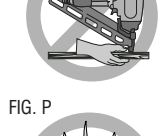

FIG. Q

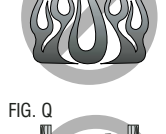

FIG. R

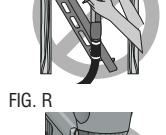

FIG. S

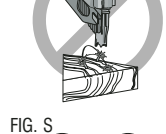

FIG. T

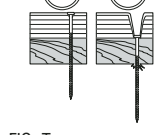

FIG. U



- **Use the tool only for its intended use. Do not discharge fasteners into open air, concrete, stone, extremely hard woods, knots or any material too hard for the fastener to penetrate. Do not use the body of the tool or top cap as a hammer.** Discharged fasteners may follow unexpected path and cause injury. (Fig. L)
- **Always keep fingers clear of contact trip to prevent injury from inadvertent release of nails.** (Fig. M)
- **Refer to the Maintenance and Repairs sections for detailed information on the proper maintenance of the tool**
- **Always operate the tool in a clean, lighted area.** Be sure the work surface is clear of any debris and be careful not to lose footing when working in elevated environments such as rooftops.
- **Do not drive fasteners near edge of material.** The workpiece may split causing the fastener to ricochet, injuring you or a co-worker. Be aware that the nail may follow the grain of the wood (shiner), causing it to protrude unexpectedly from the side of the work material. Drive the nail perpendicular to the grain to reduce risk of injury. (Fig. N)
- **Keep hands and body parts clear of immediate work area.** Hold workpiece with clamps when necessary to keep hands and body out of potential harm. Be sure the workpiece is properly secured before pressing the nailer against the material. The contact trip may cause the work material to shift unexpectedly. (Fig. O)
- **Do not use tool in the presence of flammable dust, gases or fumes.** The tool may produce a spark that could ignite gases causing a fire. Driving a nail into another nail may also cause a spark. (Fig. P)
- **Keep face and body parts away from back of the tool cap when working in restricted areas.** Sudden recoil can result in impact to the body, especially when nailing into hard or dense material. (Fig. Q)

### BUMP ACTION TRIGGER

- **When using the bump action trigger, be careful of unintentional double fires resulting from tool recoil.** Unwanted fasteners may be driven if the contact trip is allowed to accidentally re-contact the work surface. (Fig. R)

#### TO AVOID DOUBLE FIRES:

- Do not engage the tool against the work surface with a strong force.
- Allow the tool to recoil fully after each actuation.
- Use sequential action trigger.

- **When "bump" actuating the framing nailer, always keep tool in control.** Inaccurate placement of tool can result in misdirected discharge of a fastener.

### SEQUENTIAL ACTION TRIGGER

- **When using the sequential action trigger, do not actuate the tool unless the tool is placed firmly against the workpiece.**
- **Do not drive nails onto the heads of other fasteners.** Strong recoil, jammed fasteners, or ricocheted nails may result.
- **Be aware of material thickness when using the framing nailer.** A protruding nail may cause injury.
- **Be aware that when the tool is being utilized at pressures on the high end of its operating range, nails can be driven completely through thin or very soft work material.** Make sure the pressure in the compressor is set so that nails are set into the material and not pushed completely through. (Fig. S)
- **Do not drive nails blindly into walls, floors or other work areas.** Fasteners driven into live electrical wires, plumbing, or other types of obstructions can result in injury. (Fig. T)
- **Stay alert, watch what you are doing and use common sense when operating a power tool. Do not use tool while tired or under the influence of drugs, alcohol, or medication.** A moment of inattention while operating power tools may result in serious personal injury.
- **Always assume the pneumatic nailer contains fasteners and handle it accordingly.**
- **Always check the pneumatic nailer is in good order prior to use.** Do not use the Pneumatic Nailer if the trigger and the safety mechanism are not working correctly.
- **Do not load the pneumatic nailer with fasteners when any part of the operating mechanism (trigger or nose piece) is depressed.**
- **Always take care when skew nailing or when working close to the edge of any material.**

**WARNING:** Use of this product will expose you to chemicals known to the State of California to cause cancer, birth defects and other reproductive harm. **Avoid inhaling vapors and dust, and wash hands after using.**

**BEFORE OPERATING THIS TOOL, CAREFULLY READ AND UNDERSTAND ALL INSTRUCTIONS IN THE "IMPORTANT SAFETY INSTRUCTIONS" SECTION.**

## ASSEMBLY

**CAUTION:** Disconnect air line from tool and remove fasteners from magazine before making adjustments.

### Trigger

In accordance with the ANSI Standard SNT-101-2002, the DeWALT Nailers are assembled with a sequential action trigger. A bump action trigger kit is available for purchase from DeWALT as an optional accessory. For a replacement trigger contact your authorized service center or call 1-800-4-DeWALT.

The **gray trigger** with  imprinted on the side, (Cat.# D510023 kit) is the single sequential action trigger and causes the tool to operate in this mode.

The **black trigger** with  imprinted on the side, (Cat.# D510020 kit) is the bump action trigger and permits the tool to be actuated in this manner.

For defining the use of the **sequential action trigger** and **bump action trigger**, see the **Actuating Tool** section of this manual.

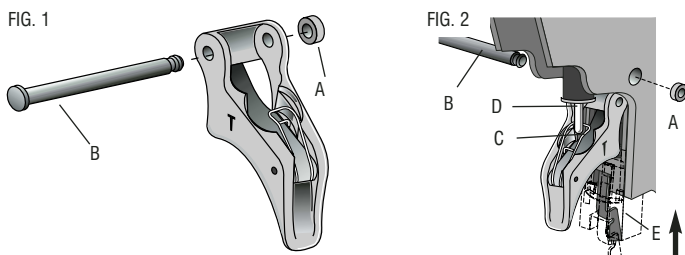

### TRIGGER REMOVAL (FIG. 1)

1. Remove rubber grommet (A) from the end of the dowel pin (B).
2. Remove dowel pin.
3. Remove trigger assembly from trigger cavity under the handle of the tool housing.

### TRIGGER INSTALLATION (FIG. 2)

1. Select either the sequential or bump action trigger to be installed on the tool.
2. Insert the trigger assembly into trigger cavity making sure that the trigger spring (C) is placed around trigger valve stem (D).
3. Ensure that the contact trip guide (E) is pushed fully upward so that it is flush with the tool housing and aligned with the housing holes.
4. Insert the dowel pin (B) through the tool frame and trigger assembly as shown.
5. Push the rubber grommet (A) onto the end of the dowel rod.

### Air Fitting

The DeWALT framing nailers have a standard 3/8" pipe thread for the air fitting. The tool is assembled with a 3/8" to 1/4" adapter installed in the end cap.

### TO INSTALL AN AIR FITTING

1. Wrap the male end of the fitting with teflon tape prior to assembly to eliminate air leaks.
2. **To install a 1/4" fitting:** screw the fitting into the 3/8" to 1/4" adapter in the end cap of the tool and tighten firmly.
3. **To install a 3/8" fitting:** screw it directly into the end cap. If an adapter is in the end cap, remove it prior to inserting the fitting.

## OPERATION

### Preparing the Tool (Fig. 3, 4)

**WARNING:** Read the section titled "Important Safety Instructions for Pneumatic Tools" at the beginning of this manual. Always wear eye and ear protection when operating this tool. Keep the nailer pointed away from yourself and others. For safe operation, complete the following procedures and checks before each use of the nailer.

1. Before you use the framing nailer, be sure that the compressor tanks have been properly drained.
2. Lubricate the tool following these directions:
  - a. Use DeWALT Pneumatic Tool Oil or a non-detergent S.A.E. 20 weight oil. DO NOT use detergent oil or additives as they will damage O-rings and rubber parts.
  - b. Use a Filter-Regulator-Lubricator in the air line between the compressor and the tool when possible.
  - c. If a lubricator is not available, add 5 to 10 drops of oil in the air fitting a least twice a day or every 4 hours of use.
3. Be sure that there are no fasteners in the magazine. Lock the pusher in the back position.
4. Check for smooth and proper operation of contact trip and pusher assemblies. Do not use tool if either assembly is not functioning properly. NEVER use a tool that has the contact trip restrained in the up position.
5. Check air supply. Be sure that air pressure does not exceed recommended operating limits; 70 to 120 psi, (4.9 to 8.3 bar, 5 to 8.5 kg/cm<sup>2</sup>).
6. Connect air hose.
7. Check for audible leaks around valves and gaskets. Never use a tool that leaks or has damaged parts.

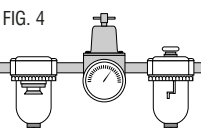
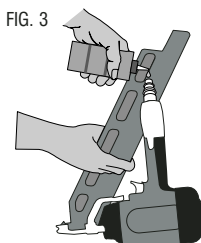

### Cold Weather Operation

**WARNING:** Read the section titled "Important Safety Instructions for Pneumatic Tools" at the beginning of this manual. Always wear eye and ear protection when operating this tool. Keep the nailer pointed away from yourself and others. For safe operation, complete the following procedures and checks before each use of the nailer.

When operating tools at temperatures below freezing, complete preparation procedures outlined above and follow the directions below.

1. Make sure compressor tanks have been properly drained prior to use. Always drain the compressor tanks at least once daily while using the nailer. This is especially important in cold weather because any moisture in the air in the tanks will condense in the cold temperature.
2. Keep the tool as warm as possible prior to use.
3. Put 5 to 10 drops of DeWALT Pneumatic Tool Oil or winter weight pneumatic oil containing ethylene glycol in the end cap.
4. Lower air pressure to 80 psi or less.
5. Actuate the tool 5 or 6 times into scrap lumber to lubricate O-rings.
6. Turn pressure up to operating level (not to exceed 120 psi) and use tool as normal.
7. Re-lubricate with DeWALT Pneumatic Tool Oil or winter weight pneumatic oil containing ethylene glycol in the end cap at least twice a day or after 4 hours of use.

### Hot Weather Operation

Tool should operate normally. However, keep tool out of direct sunlight as excessive heat can damage bumpers, O-rings and other rubber parts.

### Using the Lock-off (Fig. 5)

**WARNING:** Always wear eye and ear protection when making adjustments to the tool.

Each DeWALT nailer is equipped with a trigger lock-off switch (F). To engage the lock-off switch, rotate it to the right. To disengage the lock-off switch, center it. The trigger should always be locked off whenever any adjustments are made or when tool is not in use.

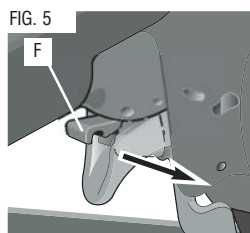

### Actuating the Tool

**WARNING:** Always wear eye and ear protection when operating tool. The tool can be actuated using one of two modes: single sequential action trigger mode and bump action trigger mode. The trigger installed on the tool as described in the **Trigger** section of this manual determines the mode of operation.

### SEQUENTIAL ACTION TRIGGER - (GRAY)

The sequential action trigger's intended use is for intermittent nailing where very careful and accurate placement is desired.

**To operate the nailer in sequential action mode:**

1. Depress the contact trip firmly against the work surface.
2. Depress the trigger.

**CAUTION:** A nail will fire each time the trigger is depressed as long as the contact trip remains depressed.

### BUMP ACTION TRIGGER - (BLACK)

The bump action trigger's intended use is for rapid nailing on flat, stationary surfaces.

Using the bump action trigger, two methods are available: **place actuation** and **bump actuation**.

**To operate the tool using the PLACE ACTUATION method:**

1. Depress the contact trip against the work surface.
2. Depress the trigger.

**To operate the tool using the BUMP ACTUATION method:**

1. Depress the trigger.
2. Push the contact trip against the work surface. As long as the trigger is depressed, the tool will fire a nail every time the contact trip is depressed. This allows the user to drive multiple nails in sequence.

**CAUTION:** Do not keep trigger depressed when tool is not in use. Keep the lock-off switch rotated to the right (OFF) when the tool is not in use.

### Loading the Tool (Fig. 6)

**CAUTION:** Keep tool pointed in a safe direction when loading nails.

**CAUTION:** Never load nails with the contact trip or trigger activated.

1. Pull the nail pusher (H) back until it latches.
2. Drop appropriate collated nail sticks into loading slot on top of magazine. See tool specifications to determine appropriate nail sizes and angles.
3. Pull the nail pusher a second time to release latch, and carefully allow the pusher to slide forward until it makes contact with the nails.

FIG. 6

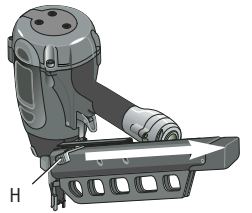

### Dry Fire Lockout

To protect from internal damage, the DeWALT Framing Nailers are equipped with a dry fire lockout, which prevents the tools from actuating when the magazine is nearly empty. When approximately 4 or 5 nails remain in the magazine and the tool ceases to operate, follow the loading instructions to reload sticks of collated nails.

### Depth Setting (Fig. 7)

**WARNING:** Always disconnect tool from air supply before adjusting depth.

Fastener driving depth can be adjusted using the depth adjustment on the nose piece of the tool.

1. To drive the nail less deeply, press the adjustment button (M) and slide the contact trip (E) down. Release the adjustment button.
2. To sink a nail farther, press the adjustment button (M) and slide the contact trip (E) upward to the extent desired. Release the adjustment button.

FIG. 7

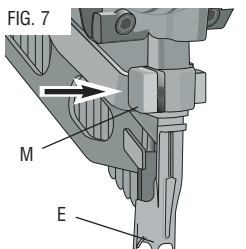

## MAINTENANCE

### Daily Maintenance Chart

<b>ACTION</b>	Lubricate tool with 5-10 drops of DeWALT Pneumatic Tool Oil
<b>WHY</b>	Prevents failure of O-rings
<b>HOW</b>	Insert drops into air fitting on end cap of tool
<b>ACTION</b>	Drain compressor tanks and hoses daily
<b>WHY</b>	Prevents accumulation of moisture in compressor and nailer
<b>HOW</b>	Open petcocks or other drain valves on compressor tanks. Allow any accumulated water to drain from hoses
<b>ACTION</b>	Clean magazine, pusher, and contact trip mechanism
<b>WHY</b>	Permits smooth operation, reduces wear, and prevents jams
<b>HOW</b>	Blow clean with compressed air. The use of oils or solvents is not recommended as they tend to attract debris
<b>ACTION</b>	Before each use, check to ensure all screws, nuts and fasteners are tight and undamaged
<b>WHY</b>	Prevents jams, leaks and premature failure of tool parts
<b>HOW</b>	Tighten loose screws or other fasteners using the appropriate Allen wrench or screwdriver

### Repairs

To assure product SAFETY and RELIABILITY, repairs, maintenance and adjustment should be performed by authorized service centers or other qualified service personnel. Always use identical replacement parts. Refer to the Troubleshooting Guide at the end of this section.

### Accessories

Recommended accessories for use with your tool are available for purchase from your local dealer or authorized service center. If you need assistance in locating any accessory for your tool, contact: DeWALT Industrial Tool Co., 701 East Joppa Road, Baltimore, MD 21286 or call 1-800-4-DeWALT.

**CAUTION:** The use of any other accessory not recommended for use with this tool could be hazardous.

### Guarantee

Applicable to hand help Power Tools, Lasers and Nailers.

### Three Year Limited Warranty

DeWALT will repair, without charge, any defects due to faulty materials or workmanship for three years from the date of purchase. Please return the complete unit, transportation prepaid, to any DeWALT Service Centre, or any authorized service station.

For warranty repair information, call 1800 654 155.

This warranty does not apply to

- Accessories
- Damage caused where repairs have been made or attempted by others.
- Damage due to misuse, neglect, wear and tear, alteration or modification.

This warranty gives you specific legal rights and you may have other rights under the provisions of the Consumer Guarantee Act 1993 (New Zealand only), Trade Practices Act 1974 and State Legislation (Australia only).

In addition to the warranty, DeWALT tools are covered by our:

### FREE ONE YEAR SERVICE CONTRACT

DeWALT will also maintain the tool for free at any time during the first year of purchase. This includes labour, parts and lubrication required to restore the product to sound mechanical and/or electrical condition. Normal wear parts are not covered in this service. Carbon brushes worn more than 50% will be replaced.

**NOTE:** 3 Year Warranty is not applicable to items deemed as consumables. Radial arm saws are covered by a one (1) year warranty only. DeWALT Reserves the right to review its warranty policy prior to launch of any new business development products.

### 30 DAY NO SATISFACTION GUARANTEE

If you are dissatisfied with any DeWALT power tool, laser or nailer, for any reason, simply return it to the point of purchase with your sales receipt within 30 days for a replacement unit or a full refund.

**FREE WARNING LABEL REPLACEMENT:** If your warning labels (Fig. 8) become illegible or are missing, call 1800-654-155 for a free replacement.

FIG. 8

**TO ADJUST DEPTH**



**WARNING**

DISCONNECT AIR & LOCK OFF TRIGGER

1. PUSH / HOLD DOWN BUTTON
2. SLIDE NOSEPIECE TO ADJUST



**BUMP ACTION TRIGGER (BLACK)**



**SEQUENTIAL ACTION (GRAY)**

**D51822 CLIPPED HEAD FRAMING NAILER**

2" - 3 1/2" x .113"-.131" DIA. ( 50-90mm x 2.8-3.3mm DIA.)

ACCEPTS ONLY 31-34 DEGREE CLIPPED HEAD FRAMING NAILS



---

**TO ADJUST DEPTH**



**WARNING**

DISCONNECT AIR & LOCK OFF TRIGGER

1. PUSH / HOLD DOWN BUTTON
2. SLIDE NOSEPIECE TO ADJUST



**BUMP ACTION TRIGGER (BLACK)**



**SEQUENTIAL ACTION (GRAY)**

**D51844 FULL ROUND HEAD FRAMING NAILER**

2" - 3 1/2" x .113"-.148" DIA. ( 50-90mm x 2.8-3.7mm DIA.)

ACCEPTS ONLY 20-22 DEGREE FULL ROUND HEAD FRAMING NAILS



**WARNING Avertissement** READ AND UNDERSTAND TOOL LABELS AND MANUAL. FAILURE TO FOLLOW WARNINGS COULD RESULT IN DEATH OR SERIOUS INJURY. OPERATORS AND OTHERS IN WORK AREA MUST WEAR ANSI Z87.1 SAFETY GLASSES WITH SIDE SHIELDS. KEEP FINGERS AWAY FROM TRIGGER WHEN NOT DRIVING FASTENERS TO AVOID ACCIDENTAL FIRING. CHOICE OF TRIGGERING METHOD IS IMPORTANT. CHECK MANUAL FOR TRIGGERING OPTIONS. NEVER DISABLE TRIGGER, CONTACT TRIP LOCK-OFF DEVICE. USE LOCK-OFF WHEN TOOL IS NOT IN USE. ENSURE TRIGGER AND CONTACT TRIP OPERATE PROPERLY BEFORE USE. NEVER POINT TOOL AT YOURSELF OR OTHERS IN WORK AREA. NEVER USE OXYGEN OR OTHER BOTTLED GASSES. EXPLOSION MAY OCCUR. DISCONNECT AIR BEFORE SERVICING TOOL, CLEARING JAMS, AND ADJUSTING DEPTH. A TITRE PREVENTIF, LIRE LE GUIDE. DEWALT INDUSTRIAL TOOL CO., BALTIMORE, MD 21286 USA FOR SERVICE INFORMATION, CALL 1-800-4-DEWALT www.DEWALT.com

**TYPICAL NAILS ACCEPTED BY THE D51822 AND D51844 FRAMING NAILERS**

**ROOF DECKING, SHEATHING AND SUBFLOORING**

**FRAMING, DECK BUILDING AND STRUCTURAL**

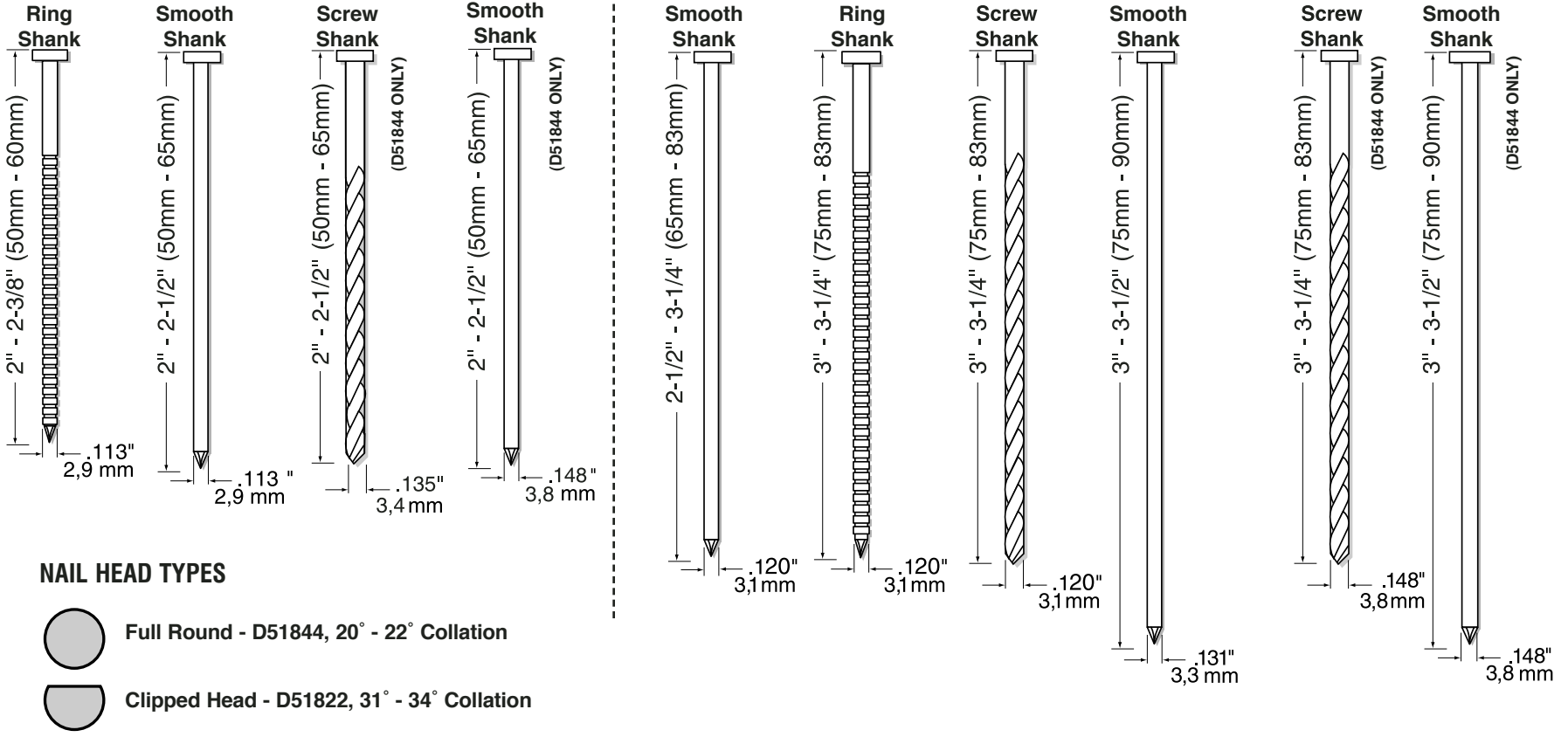

**Compressor will be sufficient for tools at all production rates.**

**Compressor will be sufficient at slow or moderate production rates, but may have difficulty at very rapid rates.**

**Compressor will be adequate only when tools are utilized at slow production rates. (punch-out or occasional use)**

**NR Not Recommended**

	Portable Handcarry 3.2 - 4 CFM	5.5 HP Gas 2 HP Elec. 8 - 9 CFM	8 HP Gas 14 - 16 CFM	Industrial 23+ CFM
1				
2				
3				
4	NR			
5	NR			
6	NR	NR		
7	NR	NR		
8+	NR	NR		

<b>Troubleshooting Guide</b>		
<b>MANY COMMON PROBLEMS CAN BE SOLVED EASILY BY UTILIZING THE CHART BELOW. FOR MORE SERIOUS OR PERSISTENT PROBLEMS, CONTACT A DeWALT SERVICE CENTER OR CALL 1-(800)-4-DeWALT.</b>		
<b>▲ DISCONNECT AIR FROM TOOL BEFORE ALL REPAIRS</b>		
Trigger valve housing leaks	O-ring or valve stem failure	Replace valve using Trigger Valve Kit: Cat. # D510005
Top cap leaks air	Loose cap screws Damaged or worn gasket or O-ring	Tighten cap screws using appropriate allen wrench Replace gasket/O-rings using Nailer O-ring Repair Kit, Cat. # D518005
Exhaust leaks	Main seal or O-ring damaged, debris in tool.	Replace gasket/O-rings using Framing Nailer O-ring Repair Kit, Cat. # D518005
Air leaks around nose when tool is at rest. (Driver blade in up position.)	Damaged or worn O-rings	Replace gasket/O-rings using Framing Nailer O-ring Repair Kit, Cat. # D518005
Air leaks around nose when tool is in actuated position. (Driver blade in down position.)	Damaged or worn bumper	Replace bumper using: Frame Nailer Bumper Kit, Cat. # D518003
Tool does not cycle in cold weather	Tool not receiving air Valve may be frozen  Damaged or worn O-rings Broken or damaged driver blade	Check air supply Warm up tool. Lubricate with DeWALT Pneumatic Tool Oil or winter weight pneumatic oil containing ethylene glycol Replace gasket/O-rings using Framing Nailer O-ring Repair Kit, Cat. # D518005 Replace Driver Blade using either Kit: Driver Blade Kit for D51844 Full Round Head Nailer; Cat. # D518452 or Driver Blade Kit for D51822 Clipped Head Nailer; Cat. # D518232
Lack of power; sluggish	Low air pressure Lack of lubrication Damaged or worn O-rings Exhaust port blocked or clogged Depth adjustment set too shallowly Driver damaged or worn	Check air supply Lubricate tool using DeWALT pneumatic tool oil. Replace gasket/O-rings using Framing Nailer O-ring Repair Kit, Cat # D518005 Disconnect air, remove exhaust plate from top of tool, clean port Reset depth adjustment Replace driver blade
Skipping nails; intermittent feed	Air restricted Lack of lubrication Nosepiece screws loose Wrong size/angle fasteners Dirty magazine Damaged/Worn magazine Broken or damaged driver blade	Check air supply and couplers Lubricate tool using DeWALT pneumatic tool oil Tighten nosepiece screws using appropriate allen wrench Use only recommended fasteners Clean magazine track and nosepiece Replace magazine Replace driver blade using either Kit: Driver Blade Kit for D51844 Full Round Head Nailer; Cat. # D518452 or Driver Blade Kit for D51822 Clipped Head Nailer; Cat. # D518232
Skipping nails; intermittent feed (cont.)	Trigger valve O-ring worn or damaged Worn piston O-ring Worn or damaged pusher spring	Replace valve using Trigger Valve Kit; Cat. # D510005 Replace O-ring using Framing Nailer O-ring Repair Kit, Cat # D518005 Replace spring using Magazine Pusher Spring Kit; Cat. # D518004
Fasteners jam in tool	Driver channel in nose piece worn Wrong size/ angle fasteners Worn driver blade  Nosepiece screws loose Nails not feeding properly	Replace nosepiece Use only recommended fasteners Replace driver blade using either Kit: Driver Blade Kit for D51844 Full Round Head Nailer; Cat # D518452 or Driver Blade Kit for D51822 Clipped Head Nailer; Cat. # D518232 Tighten nosepiece screws using appropriate allen wrench Ensure nails are feeding properly through the magazine and into the nose.